



LSK

Iluminación lineal confortable y de alta calidad
Comfortable and high quality linear lighting

- Luminaria lineal modular de superficie
- Luz continua y homogénea
- Potencia: 28.8 W/m | 35 W/m
- Voltaje: 24 VDC | 48 VDC
- Medidas: sistema modular múltiple de 100 mm
- Cuerpo: perfil de aluminio anodizado con difusor opal o de policarbonato transparente prismático

- Surface modular linear lighting system
- Continuous and homogeneous light
- Power: 28.8 W/m | 35 W/m
- Voltage: 24 VDC | 48 VDC
- Lengths: Modular system multiple of 100 mm
- Body: anodized aluminium profile with opal or clear polycarbonate prismatic diffuser

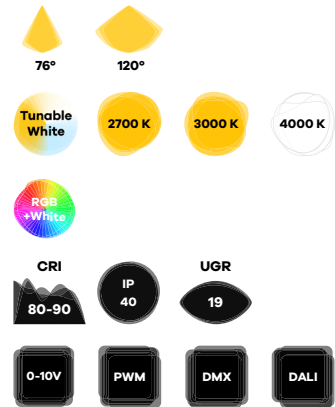



DESCRIPCIÓN | DESCRIPTION

LSK es un sistema modular lineal de superficie, ideal para crear líneas de luz continuas y uniformes sin sombras.

Fabricada en aluminio y con un sistema de disipación pasivo de alto rendimiento, la luminaria está disponible con difusor opal o prismático.

Para crear diferentes ambientes, LSK está disponible en temperaturas de color monocromáticas (2700 K, 3000 K, 4000 K), blanco dinámico (2700 K – 5000 K) y RGB+W.

Una excelente opción para la iluminación general en oficinas (UGR19), retail, centros comerciales y hoteles, entre otras aplicaciones.

LSK is a linear modular surface system, very suitable to create continuous and uniform light without shadows.

Made with extruded aluminium and with high passive dissipation performance, the luminary is available with opal or clear polycarbonate prismatic diffuser.

In order to create different atmospheres, LSK is available in monochromatic colour temperatures (2700 K, 3000 K, 4000 K), tunable White (2700 K – 5000 K) and RGB+W.

An excellent choice for offices (UGR<19), retail, shopping malls, hotels, among other applications.

CARACTERÍSTICAS TÉCNICAS | TECHNICAL SPECIFICATIONS

LSK 28 W/m

Referencia Reference	Voltaje Voltage V DC	Potencia Power W/m	Temp. color Color temp. K	CRI	Flujo Flux lm/m		Eficiencia Efficiency lm/W		Ángulo Beam °		Cantidad Number LED	Regulación Dimmer
					Opal	Prismático Prismatic	Opal	Prismático Prismatic	Opal	Prismático Prismatic		
LEA-270-100-xNP-EGI	24	28	2700	>80	1730	2000	60	69	120	76	140	PWM
LEA-300-100-xNP-EGI			3000		1860	2150	65	75				
LEA-400-100-xNP-EGI			4000		1980	2300	69	80				
LEA-270-100-xNP-EEI			>90	2700	1700	1971	59	68				
LEA-300-100-xNP-EEI				3000	1810	2100	63	73				
LEA-400-100-xNP-EEI				4000	1917	2241	67	78				

LSK 35 W/m

LEA-270-100-xNP-EGJ	48	35	2700	>80	2370	2750	68	79	120	76	210	PWM
LEA-300-100-xNP-EGJ			3000		2550	2950	73	84				
LEA-400-100-xNP-EGJ			4000		2720	3150	78	90				
LEA-270-100-xNP-EEJ			>90	2700	2331	2664	67	76				
LEA-300-100-xNP-EEJ				3000	2474	2886	71	82				
LEA-400-100-xNP-EEJ				4000	2664	3034	76	87				

LSK 35 W/m Tunable white

LEA-TCO-100-xNP-EGJ	48	35	Tunable White 2700- 5000	W: >80	2720 max	3150 max	78 max	90 max	120	76	WW: 210 CW: 210	PWM
LEA-TCO-100-xNP-EEJ				W: >90	2664 max	3071 max	76 max	87 max				

LSK 15 W/m RGB + 23 W/m White

LEA-RWO-100-xNP-EGH	24	RGB: 15 W: 23	W: 4000	W: >80	R: 194 G: 435 B: 98 W: 1584	R: 225 G: 505 B: 114 W: 1830	R: 39 G: 87 B: 20 W: 69	R: 45 G: 101 B: 23 W: 80	120	76	RGB: 120 W: 120	PWM
LEA-RWO-100-xNP-EEH				W: >90	R: 194 G: 435 B: 98 W: 1541	R: 225 G: 505 B: 114 W: 1794	R: 39 G: 87 B: 20 W: 67	R: 45 G: 101 B: 23 W: 78				

CARACTERÍSTICAS FÍSICAS | PHYSICAL SPECIFICATIONS

Referencia Reference	Orientación Orientation °	Temp. trabajo Work temp. °C	Temp. stock Stock temp. °C	Dimensiones Dimensions mm	Peso Weight kg/m
LEA-	Fijo Fixed	-20 ~ +45	-20 ~ +60	Múltiplo Multiple 100	0,917

Referencia Reference	Protección Protection	Disipación Disipation	Cuerpo Body	Difusor Diffuser		Acabado Finish
				Opal	Prismático Prismatic	
LEA-	IP40	Pasiva Passive	Aluminio anodizado Anodized aluminium	Polycarbonato Polycarbonate	Polycarbonato Polycarbonate	Anodizado plata Blanco Silver anodized White

Otras temperaturas de color y CRI bajo pedido | Different colour temperatures and CRI under request

FOTOMETRÍA | PHOTOMETRY

Difusor opal
Opal diffuser

120°

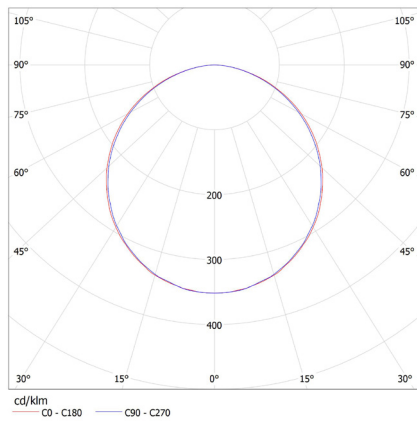

Difusor prismático
Prismatic diffuser

76°

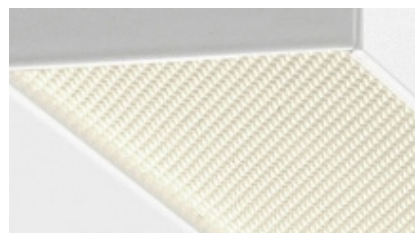
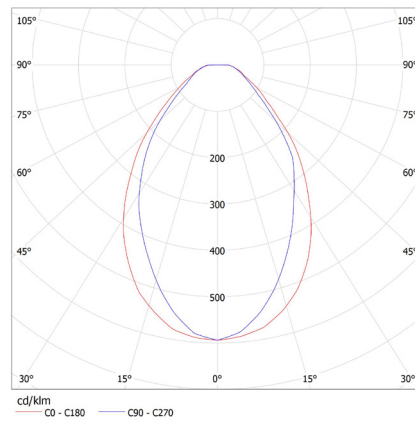

DIMENSIONES | DIMENSIONS mm

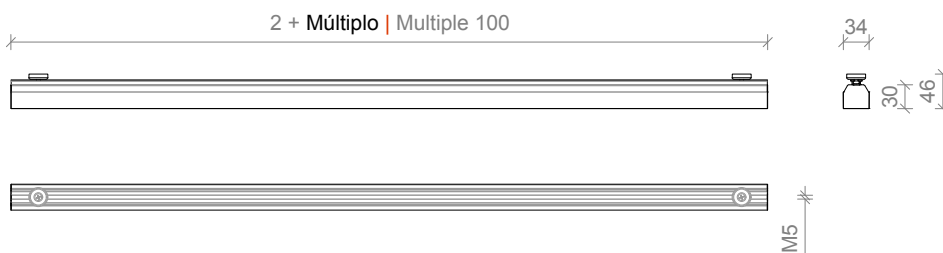

CONEXIONES | CONNECTIONS

Esquema | Diagram ON/OFF

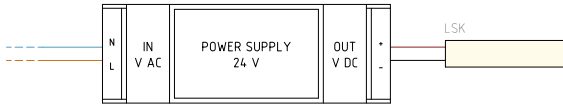

Esquema | Diagram O-10V - PWM - DALI

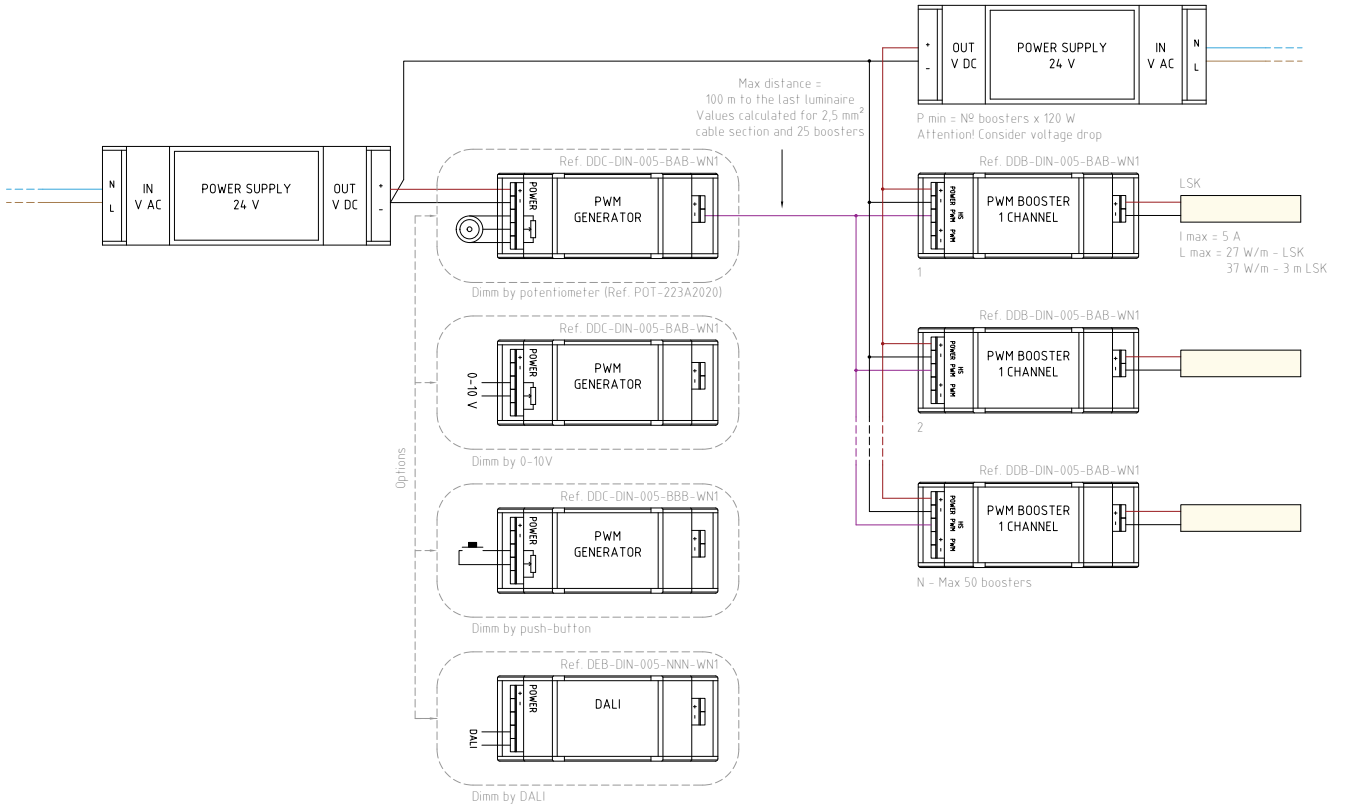

Esquema | Diagram DMX

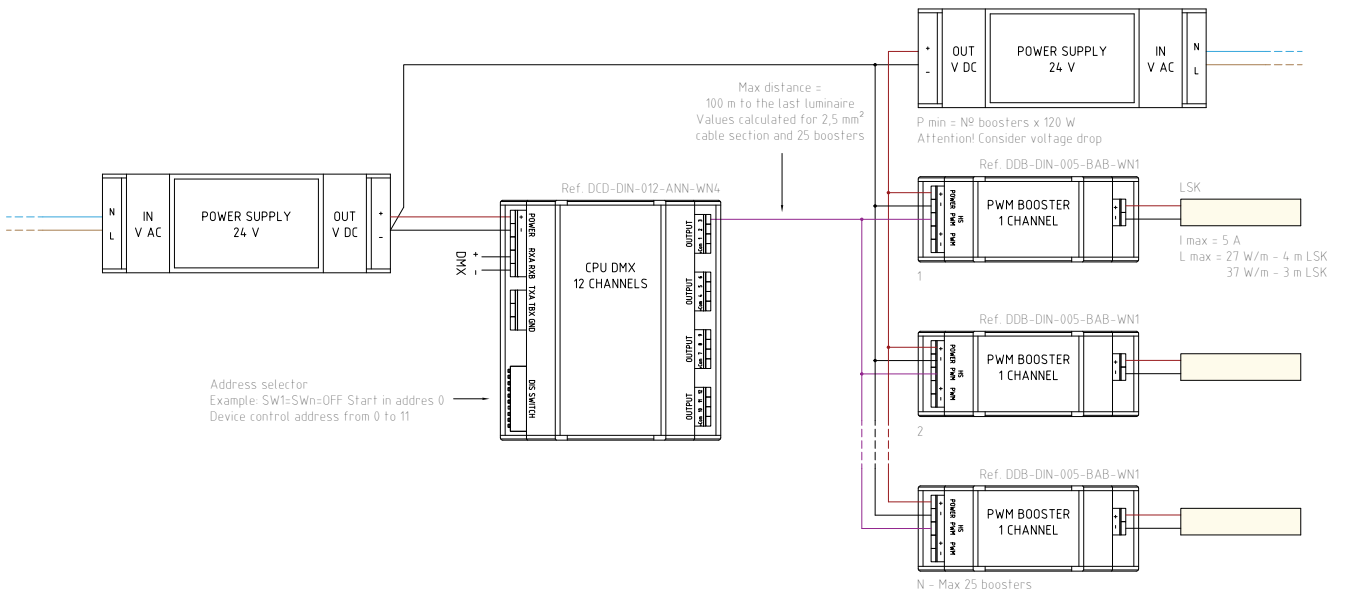

Esquema | Diagram RGB+White

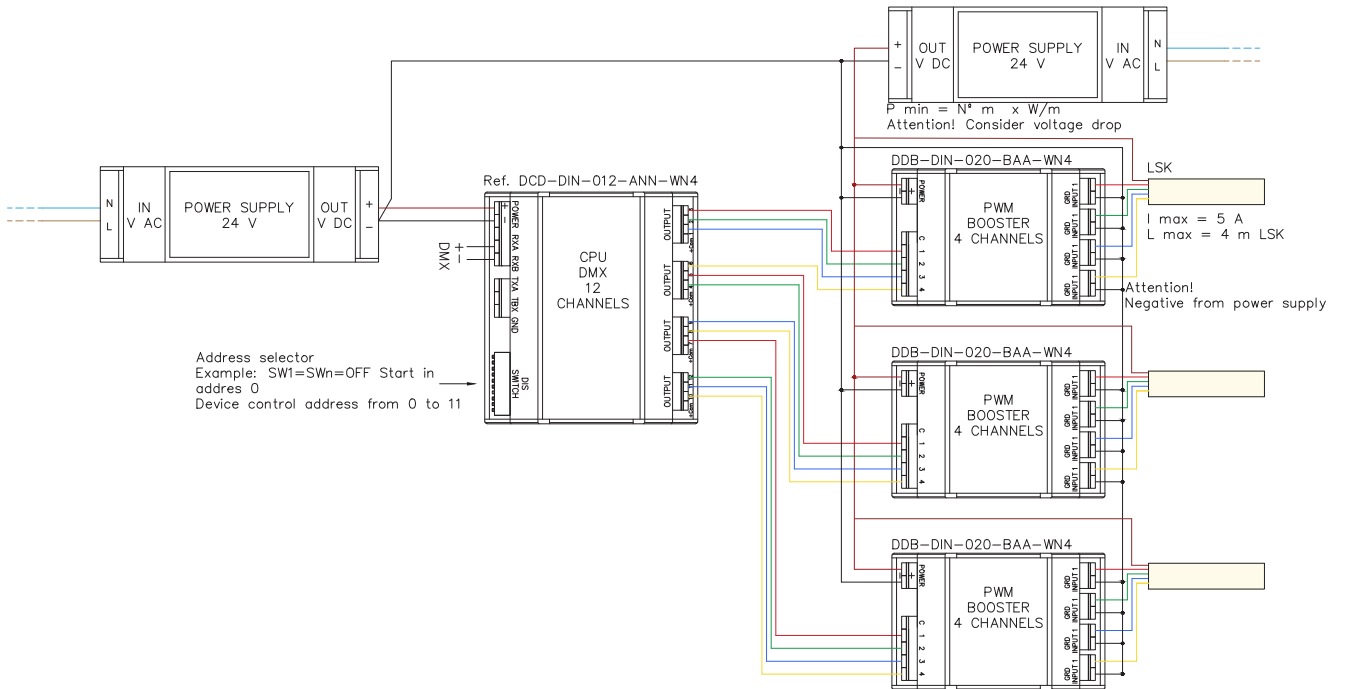

Esquema | Diagram Tunable white

